

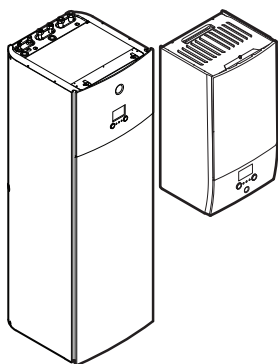

Operation manual

Daikin Altherma – Low temperature split



EBH04+08DA
EBX04+08DA

EHVH04S18DA
EHVH04S23DA
EHVH08S18DA
EHVH08S23DA
EHVX04S18DA
EHVX04S23DA
EHVX08S18DA
EHVX08S23DA

Table of Contents

- 1 About this document** **2**
- 2 About the system** **2**
 - 2.1 Components in a typical system layout 3
- 3 Operation** **3**
 - 3.1 User interface: Overview 3
 - 3.2 Possible screens: Overview 3
 - 3.2.1 Home screen..... 4
 - 3.2.2 Main menu screen 4
 - 3.2.3 Setpoint screen 5
 - 3.2.4 Detailed screen with values 5
 - 3.3 Space heating/cooling control 5
 - 3.3.1 Setting the space operation mode 5
 - 3.3.2 To change the desired room temperature..... 6
 - 3.3.3 To change the desired leaving water temperature..... 6
 - 3.4 Domestic hot water control..... 6
 - 3.4.1 Reheat mode 6
 - 3.4.2 Scheduled mode 6
 - 3.4.3 Scheduled + reheat mode..... 6
 - 3.4.4 Using DHW powerful operation..... 6
 - 3.5 Advanced usage..... 6
 - 3.5.1 To change the user permission level 6
 - 3.6 Schedule screen: Example..... 7
 - 3.7 Menu structure: Overview user settings 9
 - 3.8 Installer settings: Tables to be filled in by installer 10
 - 3.8.1 Configuration wizard 10
 - 3.8.2 Settings menu 10
- 4 Energy saving tips** **10**
- 5 Maintenance and service** **10**
 - 5.1 Overview: Maintenance and service 10
 - 5.2 To find the contact/helpdesk number 11
- 6 Troubleshooting** **11**
 - 6.1 To display the help text in case of a malfunction..... 11
 - 6.2 Symptom: You are feeling too cold (hot) in your living room..... 11
 - 6.3 Symptom: The water at the tap is too cold 11
 - 6.4 Symptom: Heat pump failure 11
- 7 Disposal** **11**
- 8 Glossary** **12**

- **General safety precautions:**
 - Safety instructions that you must read before operating your system
 - Format: Paper (in the box of the indoor unit)
- **Operation manual:**
 - Quick guide for basic usage
 - Format: Paper (in the box of the indoor unit)
- **User reference guide:**
 - Detailed step-by-step instructions and background information for basic and advanced usage
 - Format: Digital files on <http://www.daikineurope.com/support-and-manuals/product-information/>

Latest revisions of the supplied documentation may be available on the regional Daikin website or via your installer.

The original documentation is written in English. All other languages are translations.

Breadcrumbs

Breadcrumbs help you to locate where you are in the menu structure of the user interface.

1	To enable the breadcrumbs: In the home screen or main menu screen, press the help button. The breadcrumbs will appear in the top left corner of the screen.	?
2	To disable the breadcrumbs: Press the help button again.	?

This document also mentions these breadcrumbs. **Example:**

1	Go to [4.4]: Space heating/cooling > Operation range. This means: <ul style="list-style-type: none"> ▪ Starting from the home screen, turn the left dial and go to Space heating/cooling. ▪ Press the left dial to enter the submenu. ▪ Turn the left dial and go to Operation range. ▪ Press the left dial to enter the submenu. 	
----------	--	---

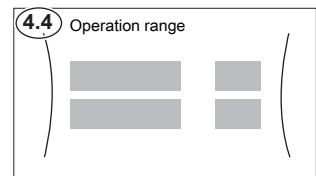
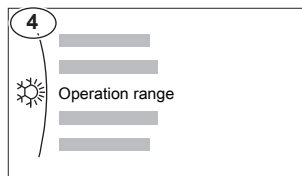

1 About this document

Thank you for purchasing this product. Please:

- Read the documentation carefully before operating the user interface to ensure the best possible performance.
- Request the installer to inform you about the settings that he used to configure your system. Check if he has filled in the installer settings tables. If not, request him to do so.
- Keep the documentation for future reference.

Target audience

End users

Documentation set

This document is part of a documentation set. The complete set consists of:

2 About the system

Depending on the system layout, the system can:

- Heat up a space
- Cool down a space (if a heating/cooling heat pump model is installed)
- Produce domestic hot water (if a DHW tank is installed)

2.1 Components in a typical system layout

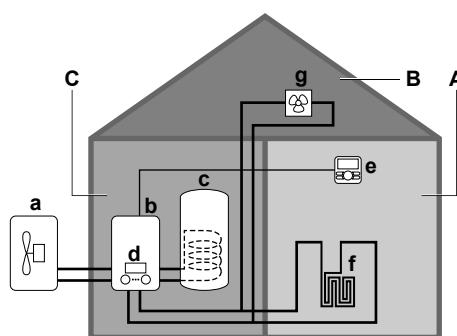

- A Main zone. **Example:** Living room.
- B Additional zone. **Example:** Bedroom.
- C Technical room. **Example:** Garage.
- a Outdoor unit heat pump
- b Indoor unit heat pump
- c Domestic hot water (DHW) tank
- d User interface at the indoor unit
- e User interface used as room thermostat
- f Underfloor heating
- g Radiators, heat pump convectors, or fan coil units



INFORMATION

The indoor unit and the domestic hot water tank (if installed) can be separated or integrated depending on the indoor unit type.

3 Operation

3.1 User interface: Overview

The user interface has the following components:

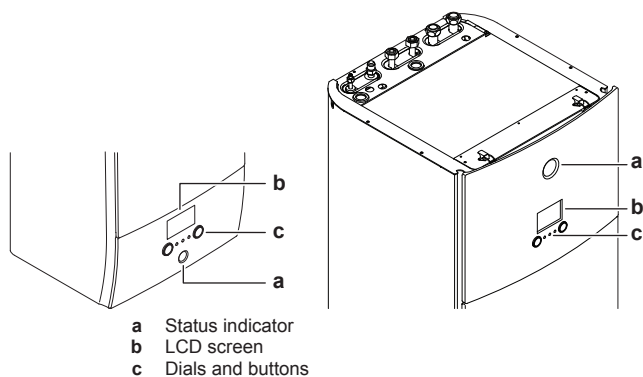

Status indicator

The LEDs of the status indicator light up or blink to show the operating mode of the unit.

LED	Mode	Description
Blinking blue	Standby	The unit is not in operation.
Continuous blue	Operation	The unit is in operation.
Blinking red	Malfunction	A malfunction occurred. See "6.1 To display the help text in case of a malfunction" on page 11 for more information.

LCD screen

The LCD screen has a sleeping function. After a certain time of non-interaction with the user interface, the screen darkens. Pressing any button or rotating any dial awakens the display. The time of non-interaction differs depending on the user permission level:

- User or Advanced user: 15 min

- Installer: 1 h

Dials and buttons

You use the dials and buttons:

- To navigate through the screens, menus and settings of the LCD screen
- To set values

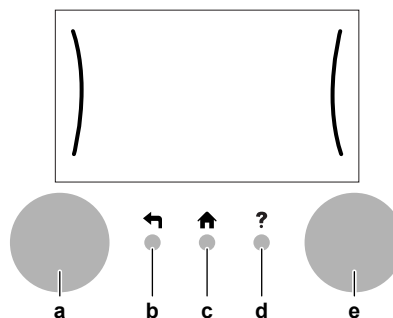

Item	Description
a Left dial	The LCD shows an arc on the left side of the display when you can use the left dial. <ul style="list-style-type: none"> • : Turn, then press the left dial. Navigate through the menu structure. • : Turn the left dial. Choose a menu item. • : Press the left dial. Confirm your choice or go to a submenu.
b Back button	: Press to go back 1 step in the menu structure.
c Home button	: Press to go back to the home screen.
d Help button	: Press to show a help text related to the current page (if available).
e Right dial	The LCD shows an arc on the right side of the display when you can use the right dial. <ul style="list-style-type: none"> • : Turn, then press the right dial. Change a value or setting, shown at the right side of the screen. • : Turn the right dial. Navigate through the possible values and settings. • : Press the right dial. Confirm your choice and go to the next menu item.

3.2 Possible screens: Overview

The most common screens are as follows:

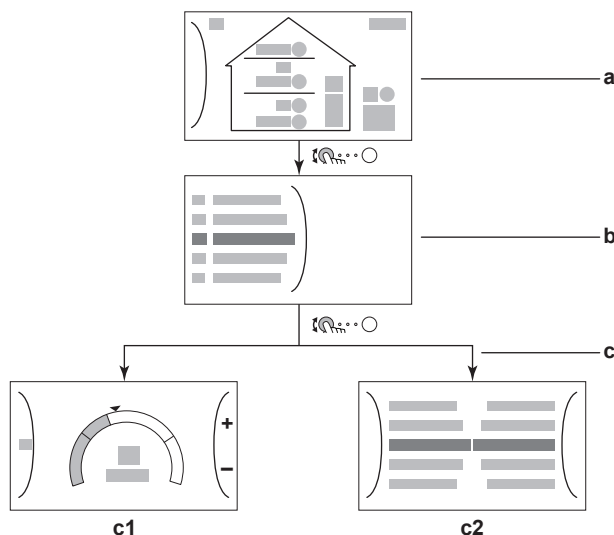

3 Operation

- a Home screen
- b Main menu screen
- c Lower level screens:
 - c1: Setpoint screen
 - c2: Detailed screen with values

3.2.1 Home screen

Press the  button to go back to the home screen. You see an overview of the unit configuration and the room and setpoint temperatures. Only symbols applicable for your configuration are visible on the home screen.

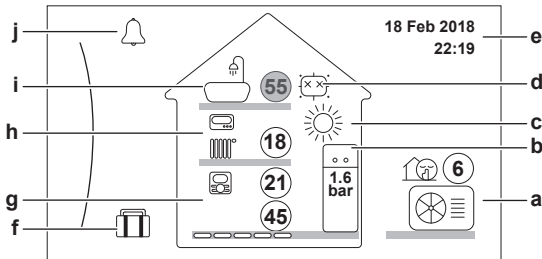

	Go through the list of the main menu.
	Go to the main menu screen.
?	Enable/disable breadcrumbs.
	The temperatures are shown in circles. If the circle is grey, the corresponding operation (example: space heating) is currently not active.

Item	Description
Outdoor unit 	a1 : Outdoor unit
	a2 : Quiet mode active
	a3 : Measured ambient temperature
Indoor unit / domestic hot water tank 	b1 Indoor unit: <ul style="list-style-type: none"> : Floor-standing indoor unit with integrated tank : Wall-mounted indoor unit with separated tank : Wall-mounted indoor unit
	b2 Water pressure
Space operation mode	c <ul style="list-style-type: none"> : Cooling : Heating
Disinfection / Powerful	d <ul style="list-style-type: none"> : Disinfection mode active : Powerful operation active
Date / time	e Current date and time
Holiday	f : Holiday mode active

Item	Description
Main zone 	g1 Heat emitter type: <ul style="list-style-type: none"> : Underfloor heating : Fancoil unit : Radiator
	g2 Leaving water temperature setpoint
	g3 Room thermostat type: <ul style="list-style-type: none"> : Daikin user interface used as room thermostat : External control Hidden: Leaving water temperature control
	g4 Measured room temperature
Additional zone 	h1 Heat emitter type: <ul style="list-style-type: none"> : Underfloor heating : Fancoil unit : Radiator
	h2 Leaving water temperature setpoint
	h3 Room thermostat type: <ul style="list-style-type: none"> : External control Hidden: Leaving water temperature control
Domestic hot water 	i1 : Domestic hot water
	i2 Measured tank temperature
Malfunction	j or : A malfunction occurred See "6.1 To display the help text in case of a malfunction" on page 11 for more information.

3.2.2 Main menu screen

In the home screen, press  to open the main menu screen. From the main menu, you can access the different setpoint screens and submenus.



	Go through the list.
	Enter the submenu.
?	Enable/disable breadcrumbs.

Item	Description
or Malfunctioning	Restriction: Only displayed if a malfunction occurs. See "6.1 To display the help text in case of a malfunction" on page 11 for more information.
Room	Restriction: Only displayed if a room thermostat is connected to the indoor unit. Set the room temperature.
Main zone	Shows the applicable symbol for your main zone configuration. Set the leaving water temperature for the main zone.

Item	Description
Additional zone	Restriction: Only displayed if there are two leaving water temperature zones. Shows the applicable symbol for your additional zone configuration. Set the leaving water temperature for the additional zone (if present).
Space heating/cooling	Shows the applicable symbol for your unit. Put the unit in heating mode or cooling mode. You cannot change the mode on heating only models.
Tank	Restriction: Only displayed if a domestic hot water tank is present. Set the domestic hot water tank temperature.
User settings	Gives access to user settings such as holiday mode and quiet mode.
Information	Displays data and information about the indoor unit.
Installer settings	Restriction: Only for the installer. Gives access to advanced settings.
Commissioning	Restriction: Only for the installer. Perform tests and maintenance.
User profile	Change the active user profile.
Operation	Turn heating/(cooling) functionality and domestic hot water preparation on or off.

INFORMATION

The Operation functionality is available in two separate locations. **Example:** You can enable the space heating/(cooling) functionality from these two locations in the menu:

- Space heating/cooling > Operation [4.1]
- Operation > Space heating/cooling [C.2]

3.2.3 Setpoint screen

The setpoint screen is displayed for screens describing system components that need a setpoint value.

Example:

- Room temperature screen
- Main zone screen
- Additional zone screen
- Tank temperature screen

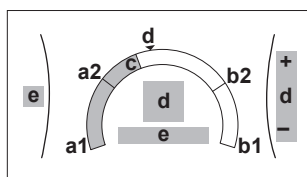

	Go through the list of the submenu.
	Go to the submenu.
	Adjust and automatically apply the desired temperature.

Item	Description	
Minimum temperature limit	a1	Fixed by the unit
	a2	Restricted by the installer
Maximum temperature limit	b1	Fixed by the unit
	b2	Restricted by the installer

Item	Description	
Current temperature	c	Measured by the unit
Desired temperature	d	Turn the right dial to increase/decrease.
Submenu	e	Turn or press the left dial to go to the submenu.

3.2.4 Detailed screen with values

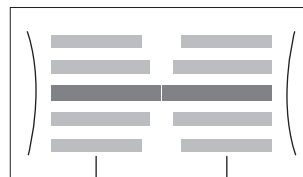

a Settings
b Values

	Go through the list of settings.
	Confirm changes and proceed.
	Change the value.
	Go to the next setting.

3.3 Space heating/cooling control

3.3.1 Setting the space operation mode

About space operation modes

Depending on your heat pump model, you have to tell the system which space operation mode to use: heating or cooling.

If a ... heat pump model is installed	Then...
Heating/cooling	The system can heat up and cool down a space. You have to tell the system which space operation mode to use.
Heating only	The system can heat up a space, but NOT cool down a space. You do NOT have to tell the system which space operation mode to use.

To tell the system which space operation to use, you can:

You can...	Location
Check which space operation mode is currently used.	Home screen
Set the space operation mode permanently.	Main menu
Restrict automatic changeover according to a monthly schedule.	

To set the space operation mode

1	Go to [4.2]: Space heating/cooling > Operation mode	
2	Select one of the following options: <ul style="list-style-type: none"> ▪ Heating: Always heating mode ▪ Cooling: Always cooling mode ▪ Automatic: The operation mode changes automatically based on the outdoor temperature. Restricted according to the operation mode schedule. 	

To restrict automatic changeover according to a schedule

Conditions: You set the space operation mode to Automatic.

1	Go to [4.3]: Space heating/cooling > Operation mode schedule	
---	--	--

3 Operation

2	Select a month in the submenu.	
3	For each month, select an option: <ul style="list-style-type: none"> Reversible: Not restricted Heating only: Restricted Cooling only: Restricted 	

3.3.2 To change the desired room temperature

During room temperature control, you can use the room temperature setpoint screen to read out and adjust the desired room temperature.

1	Go to the [1]: Room menu. You can read out the desired and actual room temperature in the center of the setpoint screen.	
2	Turn the right dial to adjust the desired room temperature.	

3.3.3 To change the desired leaving water temperature



INFORMATION

The leaving water is the water that is sent to the heat emitters. The desired leaving water temperature is set by your installer in accordance with the heat emitter type. Only adjust the leaving water temperature settings in case of problems.

You can use the leaving water temperature setpoint screen to read out and adjust the desired leaving water temperature.

1	Go to the 2: Main zone or 3: Additional zone menu. You can read out the desired and actual leaving water temperature in the center of the setpoint screen.	
2	Turn the right dial to adjust the desired leaving water temperature.	

3.4 Domestic hot water control

3.4.1 Reheat mode

In reheat mode the DHW tank continuously heats up to the temperature shown on the home screen (example: 50°C).

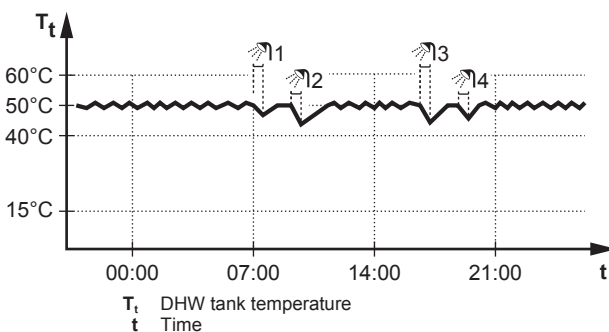

INFORMATION

Risk of space heating capacity shortage for domestic hot water tank without internal booster heater: In case of frequent domestic hot water operation, frequent and long space heating/cooling interruption will happen when selecting the following:

Tank > Heat up mode > Reheat only.



INFORMATION

When the DHW tank mode is reheat, the risk for capacity shortage and comfort problem is significant. In case of frequent reheat operation, space heating/cooling function is regularly interrupted.

3.4.2 Scheduled mode

In scheduled mode the DHW tank produces hot water corresponding to a schedule. The best time to allow the tank to produce hot water is at night, because the space heating demand is lower.

Example:

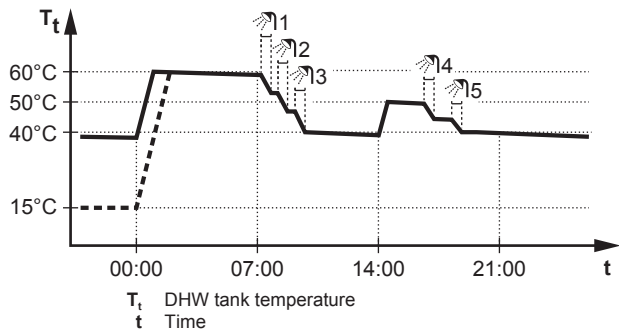

3.4.3 Scheduled + reheat mode

In scheduled + reheat mode, the domestic hot water control is the same as in scheduled mode. However, when the DHW tank temperature drops below a preset value (=reheat tank temperature – hysteresis value; example: 35°C), the DHW tank heats up until it reaches the reheat set point (example: 45°C). This ensures that a minimum amount of hot water is available at all times.

Example:

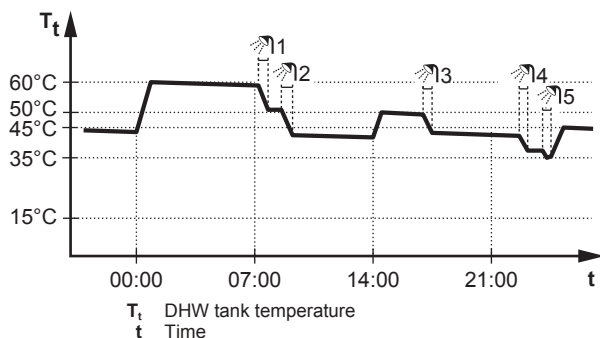

3.4.4 Using DHW powerful operation

Powerful operation allows the domestic hot water to be heated by the backup heater or booster heater. Use this mode on days when there is more hot water usage than usual.

Activate or deactivate Powerful operation as follows:

1	Go to [5.2]: Tank > Powerful operation	
2	Turn powerful operation Off or On.	

3.5 Advanced usage

The amount of information you can read out in the menu structure depends on your user permission level:

- User: Standard mode
- Advanced user: You can read out more information

3.5.1 To change the user permission level

You can change the user permission level as follows:

1	Go to [B]: User profile	
2	Enter the applicable code for the user permission.	—
	▪ Move the cursor from left to right.	
	▪ Browse through the list of digits and change the selected digit.	
	▪ Confirm the pincode and proceed.	

Advanced user pin code

The Advanced user pin code is **1234**. Additional menu items for the user are now visible.

User pin code

The User pin code is **0000**.

3.6 Schedule screen: Example

This example shows how to set a room temperature schedule in heating mode for the main zone.

INFORMATION

The procedures to program other schedules are similar.

To program the schedule

Example: You want to program the following schedule:

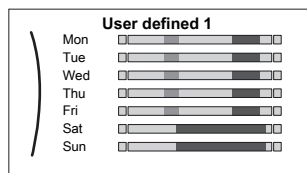

Prerequisite: The room temperature schedule is only available if room thermostat control is active. If leaving water temperature control is active, you can program the main zone schedule instead.

- 1 Go to the schedule.
- 2 Clear the contents of the schedule (optional).
- 3 Program the schedule for Monday.
- 4 Copy the schedule to the other weekdays.
- 5 Program the schedule for Saturday and copy it to Sunday.
- 6 Give the schedule a name.

To go to the schedule:

1	Go to [1.2]: Room > Schedule.	
2	Set scheduling to Yes.	
3	Go to [1.3]: Room > Heating schedule.	

To clear the contents of the schedule:

1	Select the name of the current schedule.	
2	Select Delete.	
3	Select OK to confirm.	



To program the schedule for Monday:



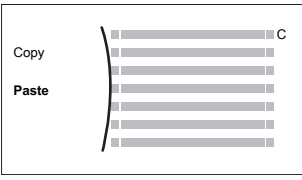
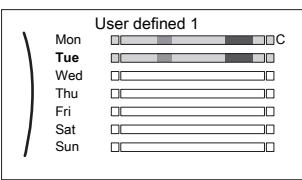

1	Select Monday.	
2	Select Edit.	
3	Use the left dial to select an entry and edit the entry with the right dial. You can program up to 6 actions each day.	
4	Confirm the changes.	

To copy the schedule to the other weekdays:

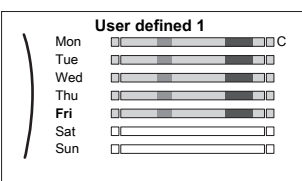

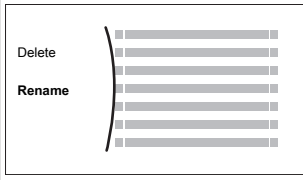





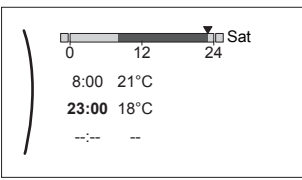

1	Select Monday.	
2	Select Copy.	
	Result: "C" is displayed next to the copied day.	
3	Select Tuesday.	

3 Operation

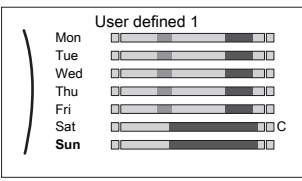

<p>4 Select Paste.</p>  <p>Result:</p> 	
<p>5 Repeat this action for all other weekdays.</p> 	<p>—</p>

<p>2 Select the Rename option.</p> 	
<p>3 Browse through the character list and confirm the selected character.</p>	
<p>4 Confirm the new name.</p>	

To program the schedule for Saturday and copy it to Sunday:

<p>1 Select Saturday.</p>	
<p>2 Select Edit.</p>	
<p>3 Use the left dial to select an entry and edit the entry with the right dial.</p> 	
<p>4 Confirm the changes.</p>	
<p>5 Select Saturday.</p>	
<p>6 Select Copy.</p>	
<p>7 Select Sunday.</p>	
<p>8 Select Paste.</p> <p>Result:</p> 	

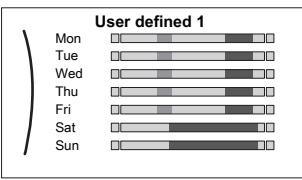
To rename the schedule:

<p>1 Select the name of the current schedule.</p> 	
--	---

3.7 Menu structure: Overview user settings

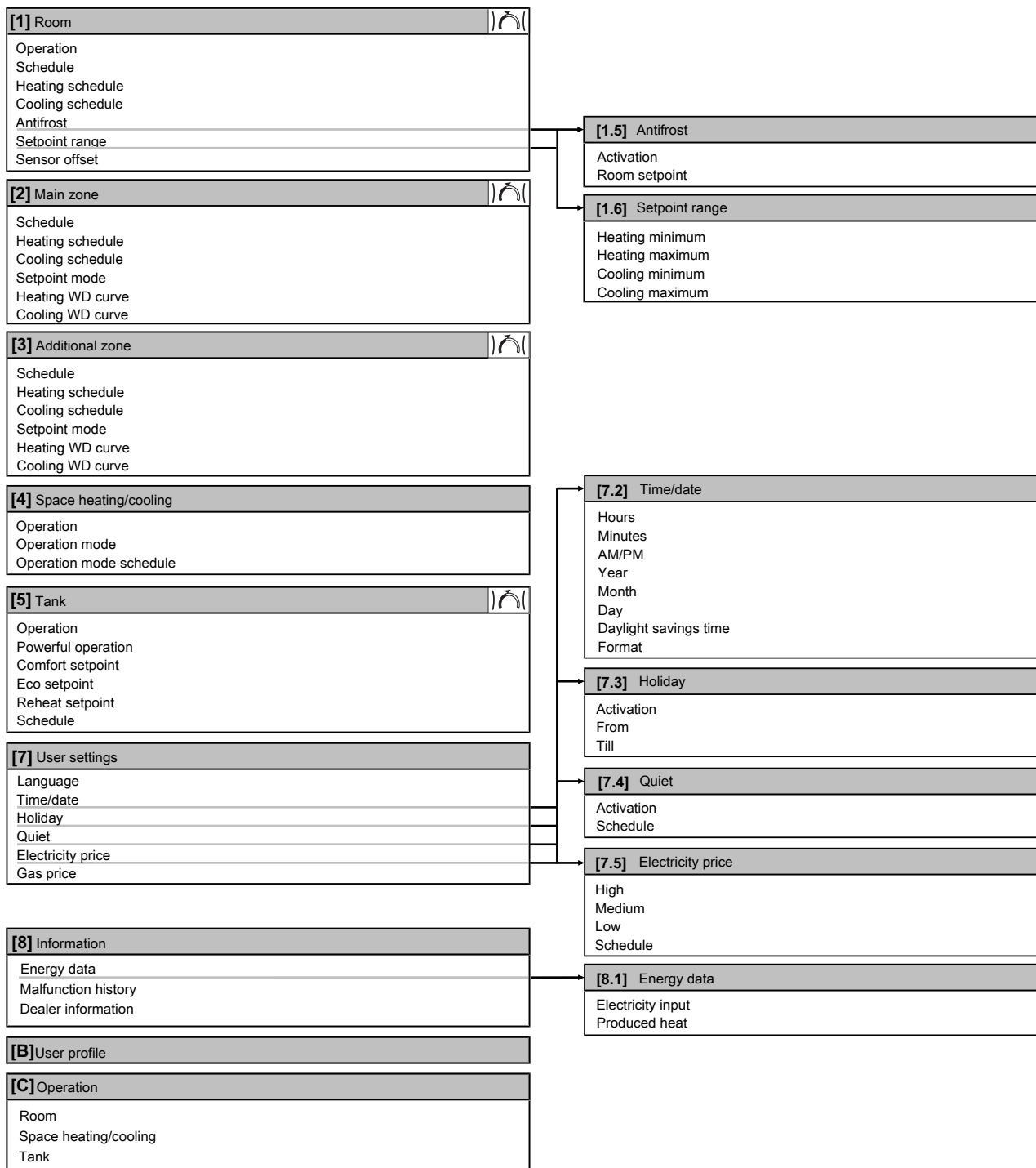

Setpoint screen



INFORMATION

Depending on the selected installer settings and unit type, settings will be visible/invisible.

4 Energy saving tips

3.8 Installer settings: Tables to be filled in by installer

3.8.1 Configuration wizard

Setting	Fill in...
System	
Indoor unit type (read only)	
Backup heater type [9.3.1]	
Domestic hot water [9.2.1]	
Emergency [9.5]	
Number of zones [4.5]	
Backup heater	
Voltage [9.3.2]	
Configuration [9.3.3]	
Capacity step 1 [9.3.4]	
Additional capacity step 2 [9.3.5] (if applicable)	
Main zone	
Emitter type [2.7]	
Control [2.9]	
Setpoint mode [2.4]	
Schedule [2.1]	
Additional zone (only if [4.5] = 1)	
Emitter type [3.7]	
Control (read only) [3.9]	
Setpoint mode [3.4]	
Schedule [3.1]	
Tank	
Heat up mode [5.7]	
Comfort setpoint [5.3]	
Eco setpoint [5.4]	
Reheat setpoint [5.5]	

3.8.2 Settings menu

Setting	Fill in...
Main zone	
Thermostat type [2.A]	
Additional zone (if applicable)	
Thermostat type [3.A]	
Information	
Dealer information [8.3]	

4 Energy saving tips

Tips about room temperature

- Make sure the desired room temperature is NEVER too high (in heating mode) or too low (in cooling mode), but ALWAYS according to your actual needs. Each saved degree can save up to 6% of heating/cooling costs.
- Do NOT increase the desired room temperature to speed up space heating. The space will NOT heat up faster.
- When your system layout contains slow heat emitters (example: under floor heating), avoid large fluctuation of the desired room temperature and do NOT let the room temperature drop too low. It will take more time and energy to heat up the room again.

- Use a weekly schedule for your normal space heating or cooling needs. If necessary, you can easily deviate from the schedule:
 - For shorter periods: You can overrule the scheduled room temperature until the next scheduled action. **Example:** When you have a party, or when you are leaving for a couple of hours.
 - For longer periods: You can use the holiday mode.

Tips about DHW tank temperature

- Use a weekly schedule for your normal domestic hot water needs (only in scheduled mode).
 - Program to heat up the DHW tank to a preset value (Storage comfort = higher DHW tank temperature) during the night, because then space heating demand is lower.
 - If heating up the DHW tank once at night is not sufficient, program to additionally heat up the DHW tank to a preset value (Storage eco = lower DHW tank temperature) during the day.
- Make sure the desired DHW tank temperature is NOT too high. **Example:** After installation, lower the DHW tank temperature daily by 1°C and check if you still have enough hot water.
- Program to turn ON the domestic hot water pump only during periods of the day when instant hot water is necessary. **Example:** In the morning and evening.

5 Maintenance and service

5.1 Overview: Maintenance and service

The installer has to perform a yearly maintenance. You can find the contact/helpdesk number via the user interface.

As end user, you have to:

- Keep the area around the unit clean.
- Keep the user interface clean with a soft damp cloth. Do NOT use any detergents.
- Regularly check if the water pressure is above 1 bar.

Refrigerant

This product contains fluorinated greenhouse gases. Do NOT vent gases into the atmosphere.

Refrigerant type: R32

Global warming potential (GWP) value: 675



NOTICE

In Europe, the **greenhouse gas emissions** of the total refrigerant charge in the system (expressed as tonnes CO₂-equivalent) is used to determine the maintenance intervals. Follow the applicable legislation.

Formula to calculate the greenhouse gas emissions:
GWP value of the refrigerant × Total refrigerant charge [in kg] / 1000

Please contact your installer for more information.



WARNING: FLAMMABLE MATERIAL

The refrigerant inside this unit is mildly flammable.



WARNING

The appliance shall be stored in a room without continuously operating ignition sources (example: open flames, an operating gas appliance or an operating electric heater).

**WARNING**

- Do NOT pierce or burn refrigerant cycle parts.
- Do NOT use cleaning materials or means to accelerate the defrosting process other than those recommended by the manufacturer.
- Be aware that the refrigerant inside the system is odourless.

**WARNING**

The refrigerant inside the unit is mildly flammable, but normally does not leak. If the refrigerant leaks in the room and comes in contact with fire from a burner, a heater, or a cooker, this may result in fire, or the formation of a harmful gas.

Turn off any combustible heating devices, ventilate the room, and contact the dealer from which you purchased the unit.

Do not use the unit until a service person confirms that the portion from which the refrigerant leaked is repaired.

5.2 To find the contact/helpdesk number

1	Go to [8.3]: Information > Dealer information.	
---	--	--

6 Troubleshooting

6.1 To display the help text in case of a malfunction

In case of a malfunction, the following will appear on the home screen depending on the severity:

- : Error
- : Malfunction

You can get a short and a long description of the malfunction as follows:

1	Press the left dial to open the main menu and go to Malfunctioning. Result: A short description of the error and the error code is displayed on the screen.	
2	Press ? in the error screen. Result: A long description of the error is displayed on the screen.	?

6.2 Symptom: You are feeling too cold (hot) in your living room

Possible cause	Corrective action
The desired room temperature is too low (high).	Increase (decrease) the desired room temperature. If the problem recurs daily, do one of the following: <ul style="list-style-type: none"> Increase (decrease) the room temperature preset value. Adjust the room temperature schedule.
The desired room temperature cannot be reached.	Increase the desired leaving water temperature in accordance with the heat emitter type.

6.3 Symptom: The water at the tap is too cold

Possible cause	Corrective action
You ran out of domestic hot water because of unusual high consumption.	If you immediately need domestic hot water, activate the DHW tank Powerful operation. However, this consumes extra energy.
The desired DHW tank temperature is too low.	If you can wait, overrule (increase) the active or next scheduled desired temperature so that more hot water will be produced exceptionally. If the problems recurs daily, do one of the following: <ul style="list-style-type: none"> Increase the DHW tank temperature preset value. Adjust the DHW tank temperature schedule. Example: Program to additionally heat up the DHW tank to a preset value (Eco setpoint = lower tank temperature) during the day.

6.4 Symptom: Heat pump failure

When the heat pump fails to operate, the backup heater and/or booster heater can serve as an emergency heater and either automatically or non-automatically take over the heat load.

- When auto emergency is set to Automatic and a heat pump failure occurs:
 - For EHVH/X: The backup heater will automatically take over the heat load and domestic hot water production
 - For EHBH/X: The backup heater will automatically take over the heat load, and the booster heater in the optional tank will automatically take over the domestic hot water production.
- When auto emergency is set to Manual and a heat pump failure occurs, the domestic hot water and space heating operation will stop and need to be recovered manually. The user interface will then ask you to confirm whether the backup heater and/or booster heater can take over the heat load or not.

When the heat pump fails, or will appear on the user interface.

Possible cause	Corrective action
Heat pump is damaged.	See "6.1 To display the help text in case of a malfunction" on page 11.

**INFORMATION**

When the backup heater or booster heater takes over the heat load, electricity consumption will be considerably higher.

7 Disposal

**NOTICE**

Do not try to dismantle the system yourself: the dismantling of the system, treatment of the refrigerant, oil and other parts must comply with applicable legislation. Units must be treated at a specialised treatment facility for reuse, recycling and recovery.

8 Glossary

8 Glossary

DHW = Domestic hot water

Hot water used, in any type of building, for domestic purposes.

LWT = Leaving water temperature

Water temperature at the water outlet of the heat pump.







ERC



4P495246-1 0000000S

Copyright 2017 Daikin

DAIKIN EUROPE N.V.

Zandvoordestraat 300, B-8400 Oostende, Belgium

4P495246-1 2017.06